

Name \_\_\_\_\_

Date \_\_\_\_\_

Find the volume.

Use 3.14 for  $\pi$ . Round all final answers to the nearest tenth as needed.

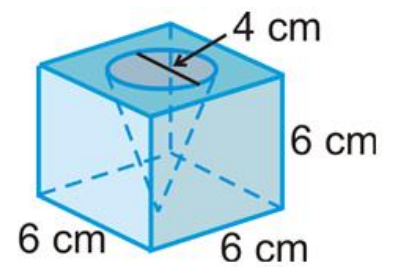
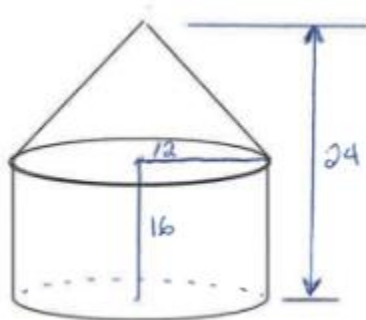
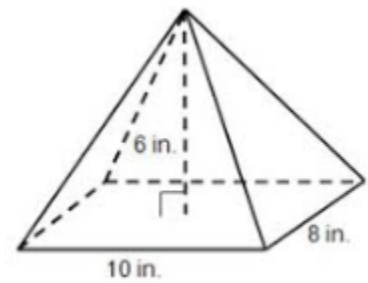
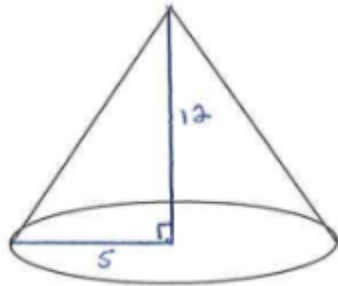
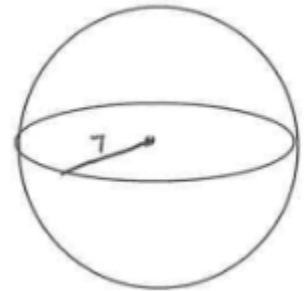
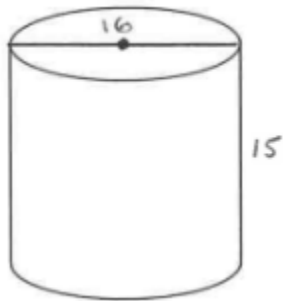
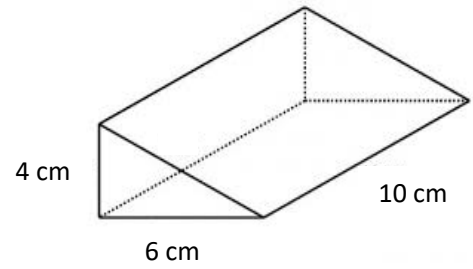
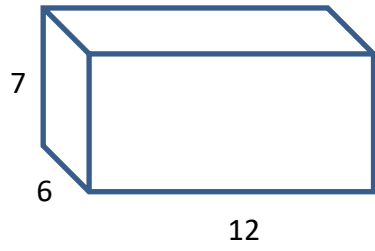

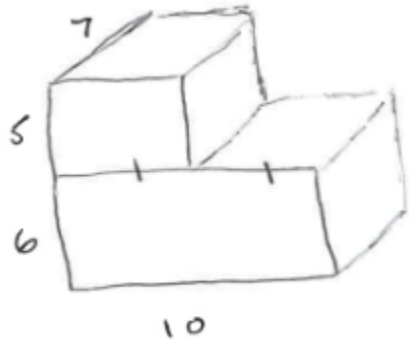

Each block is 1 x 1 x 1cm

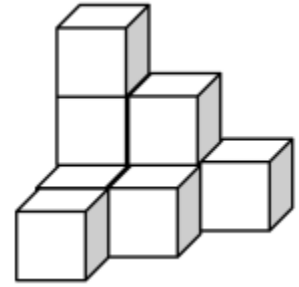

A farmer just had a new grain silo installed. It has a diameter of 18' and the cylindrical section is 35' tall.

How much grain should be ordered to fill the silo?

Two months later the farmer need to order more grain. He has determined that there is still 6' of grain in the silo. How much should he order to refill the silo?

